

## Product Guide

# Quick Change Adapters for Force Tension Calibration





## Table Contents

Description ..... 3

Application ..... 4

Tension Members ..... 6

Threaded Adapters ..... 10

Clevises ..... 14

    Mounting a Clevis ..... 15

    Clevis Pins ..... 17

        Straight Pin ..... 17

        Shoulder Pin with Bushing ..... 17

    Clevis Pin Rollers ..... 19

Numbering Schema ..... 21

    Tension Member ..... 21

    Spherical Hex Nut ..... 21

    Spherical Alignment Bushing ..... 22

    Tension Rod ..... 22

    Retaining Ring ..... 22

    Coupling Nut ..... 23

    Threaded Adapter ..... 23

    Clevis Assembly ..... 24

    Clevis ..... 24

    Clevis Straight Pin ..... 24

    Clevis Pins with Bushings Assembly ..... 25

        Clevis Shoulder Pin ..... 25

        Clevis Pin Bushing ..... 26

    Clevis Pin Roller ..... 26

## Description

Morehouse Quick-Change Tension Adapters is a system designed to perform tension force calibration in force calibrating machines and improve accuracy and work flow in force calibration laboratories. The adapter system can be used with Morehouse Universal Calibrating Machines (UCM), Morehouse Deadweight Calibrating Machines, as well as other force calibration systems available on the market. The system is highly versatile to accommodate variety of force measurement instruments, and yields significant saving for the user in terms of long-term cost of supplying calibration adapters.

Calibrating force instruments in tension always requires proper adapters, and considering the vast diversity among force instrument configurations, a general calibration laboratory might need to acquire hundreds of different adapters to perform tension calibrations. Quick-Change Tension Adapter addresses this issue by providing a system that is convertible to almost all force instrument configurations using smaller intermediate adapters which can be obtained at considerably lower cost.

Additionally, Quick-Change Tension Adapter system benefits from some built-in self-alignment features which automatically align the applied force to the appropriate force line of the instrument and eliminate misalignment which is one of the major sources of error in force calibrations. Comparison tests conducted by Morehouse and using Primary Deadweight Standards have shown that force misalignment can introduce up to 1.0 % of error into the calibration data based upon the type of instrument and calibration range.

Users of Quick-Change Tension Adapters system also take advantage of an improved work flow achieved by an organized assortment of adapters and reduced time for changing between different setups. Quick-Change Tension Members, an essential part of the Quick-Change Tension Adapter system, can be left in the calibrating machine to be used with different intermediate adapters. In other words, the tension calibration setup can be switched to a new one by simply threading in a different adapter size without need for disassembling the entire setup.

Morehouse Quick-Change Tension Adapter features:

- Improved alignment by using a spherical radius contact as defined by ISO 376
- Improved measurement repeatability by better alignment
- Reduced tension changeover and overall calibration cycle time
- Simplify setups by using one tension member with several adapters
- Fit for use with additional clevis assemblies to calibrate crane scales
- Rust resistance black oxide coating on all parts

## Application

One of the challenges of running a force calibration laboratory is access to proper adapters to mount a force instrument in calibration machines. Construction and manufacturing quality of tension adapter can greatly impact the calibration results. Misalignment of calibration setup with the applied force line can particularly introduce additional errors into the calibration data. Moreover, force measurement instruments are manufactured in many different configurations based on their application, and even within the same configuration group, calibration laboratories often face a vast diversity of setups due to each manufacturer's preferences. Force calibration labs have traditionally been spending a considerable amount of resources and time to source tension adapters, and calibration technicians have been spending a lot of time on switching to a different adapters setup every time they need to perform a tension calibration.

To address these issues, Morehouse designed and developed Quick-Change Tension Adapters as a versatile adapters system which can easily be reconfigured by the user to mount different types of instruments. As demonstrated in Figure 1, the system includes two Tension Members which are mounted on two sides on the tension calibration area in a calibrating machine: one installed on the lower yoke platen, and the other one installed on the lower fixed platen. Each Tension Member is equipped with a swiveling nut which helps with assembly and assists technicians to complete a tension setup in a shorter duration of time. In addition, each Tension Member has two self-aligning contact mechanisms, as depicted in Figure 2, which automatically align the instrument under test with force application line. This results in lowering misalignment errors in the calibration procedure and increasing repeatability of force measurement when the unit under test is rotated between different runs of calibration.

In addition to the Tension Members, Morehouse has developed a large variety of Threaded Adapters which can easily change the setup configuration to accommodate a new instrument. Special Threaded Adapters such as clevises or rod ends can also be added to the system to calibrate instruments like crane scales or dynamometers. Regardless of the type of instrument or adapters used, the system benefits from the self-aligning features of the Tension Members. Since the Tension Members stay the same for all instruments, only a relatively small adapter will be needed for a new instrument, and the rest of the setup can be used in common between all calibrations. This results in significant long-term savings for a force laboratory in term of acquiring and maintenance of tension calibration adapters.

This system helps calibration technicians with easier and faster tension setups. One of the Tension Members that is installed on the lower fixed platen can permanently stay in the machine and never come out even in compression calibration. This eliminates repeated installation of tension adapters in this part of the machine which is normally the most cumbersome part of assembling a tension calibration setup. The system also reduces the amount of shelf space required for maintaining and organizing the adapters. Morehouse customers who have started using Quick-Change Tension Adapters system have experienced a significant reduction in calibration setup time and cost, as well as improved their tension force calibration quality.

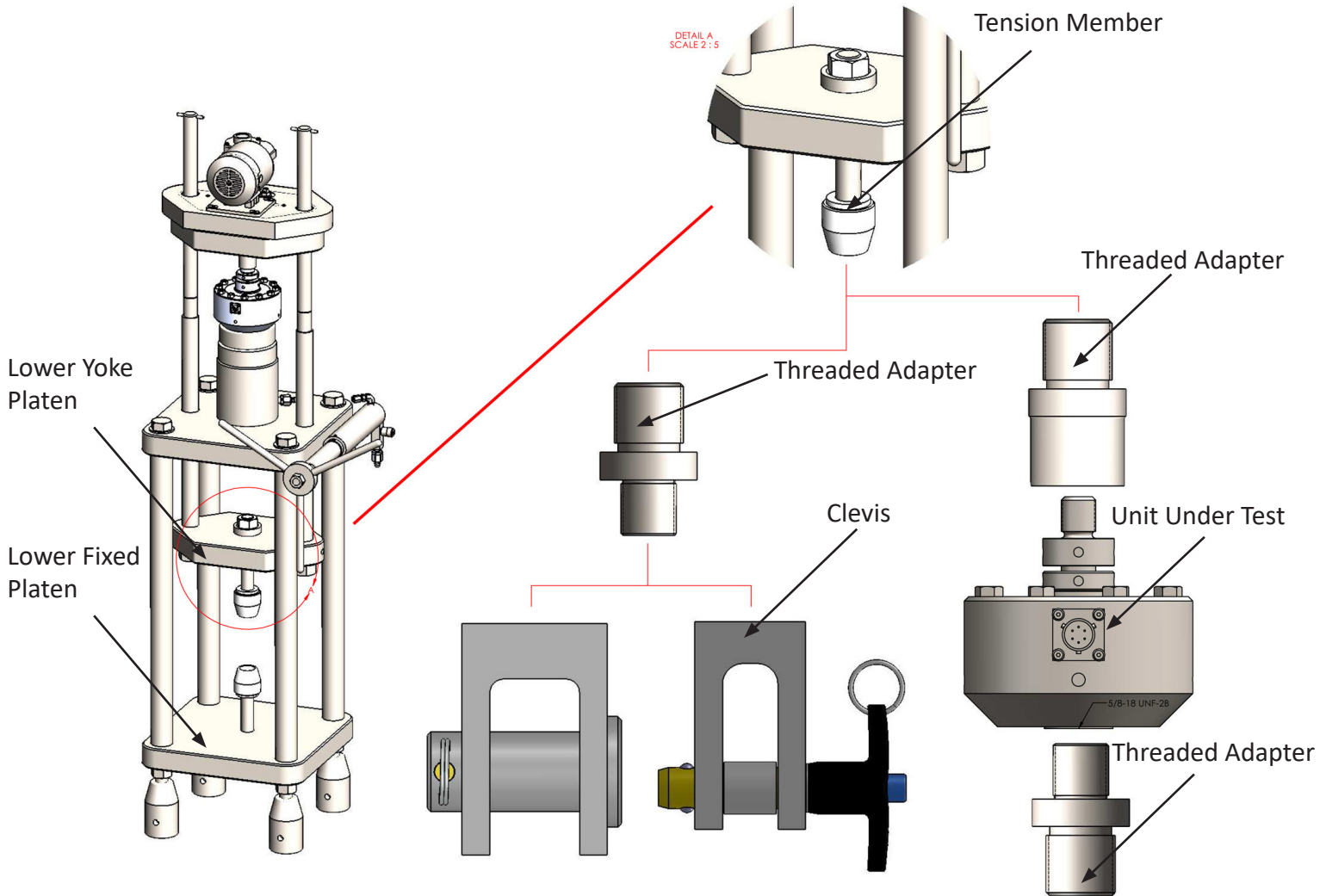

**Figure 1: Force Calibration Setup Using Quick-Change Tension Member Adapters**

## Tension Members

Each Quick-Change Tension Adapters system requires two fully assembled Tension Members mounted on the tension side of a calibrating machine. Each Tension Member is assembled of multiple parts which are manufactured based on the capacity and dimensions of the calibrating machine. Figure 2 illustrates the overall design and parts included in a Tension Member assembly. As shown in this figure, two self-aligning contact points are embedded in the design of Tension Members. One is in the contact point between Spherical Nut, and Spherical Alignment Bushing (Figure 2). Once a force is applied on the calibration setup, this spherical contact act as a joint which centers itself and aligns the Tension Rod with the force line applied by the machine. The second self-aligning mechanism is built between the end of the Tension Rod and inside of the Retaining Ring (Figure 2) which aligns the instrument under test with respect the tension rod. Therefore, the Tension Members help align the calibration setup with the machine, and generate more repeatable results, particularly after rotating the instrument between calibration runs.

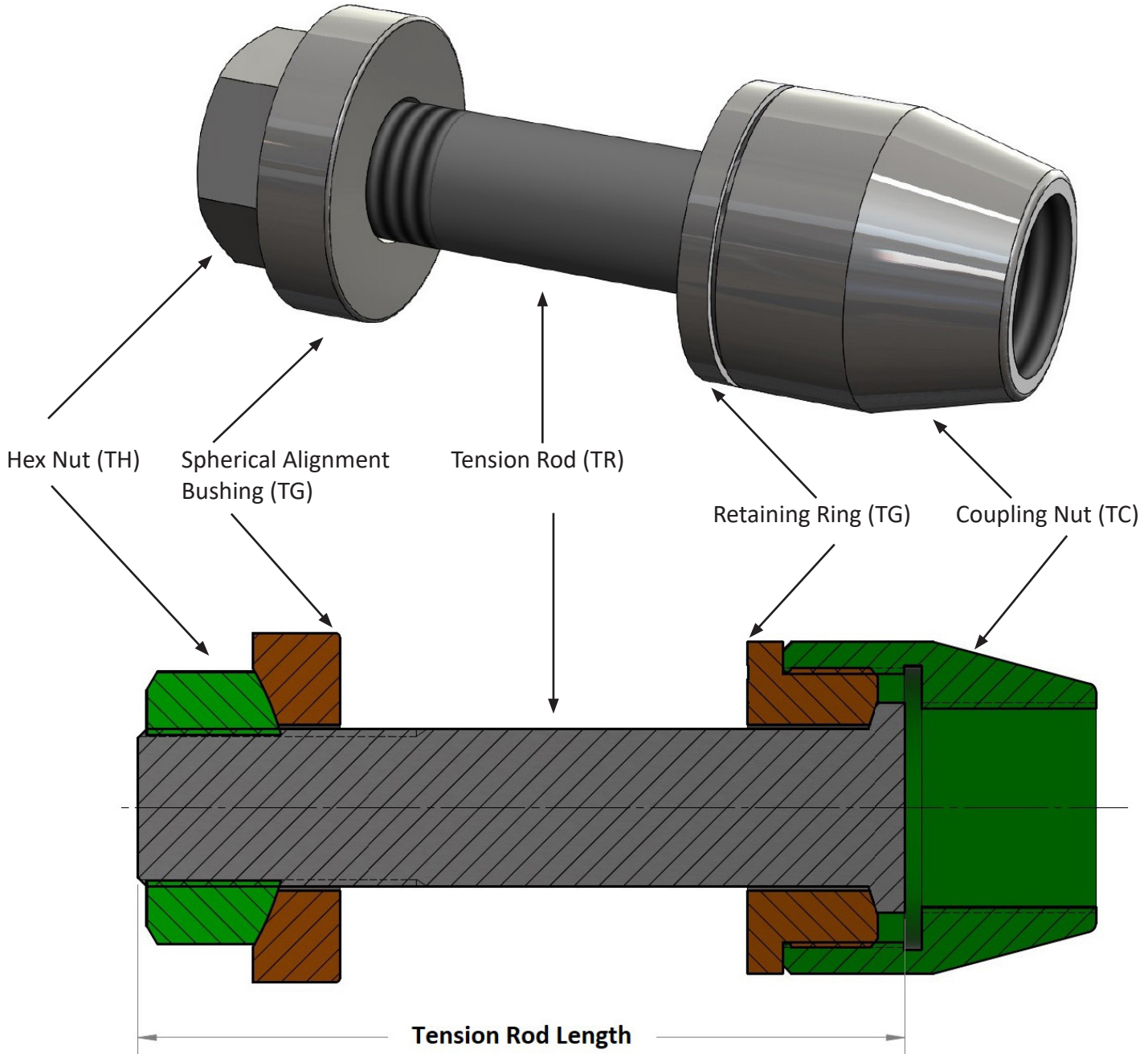

**Figure 2: Tension Member Assembly Components**

Standard sizes of Quick-Change Tension Adapter systems were designed to fit in the standard configuration of Morehouse Universal Calibrating Machines. However, the system is completely customizable and Quick-Change Tension Adapter system can be manufactured with different sizes to fit in any existing machines on the market. Moreover, upon special requirements by users, the length of Tension Rods can be modified for enlarged machines. Table 1 contains the most common standard sizes of Tension Members manufactured by Morehouse. The table includes the standard sizes for each Morehouse Universal Calibrating Machine (UCM), as well as the Tension Members that might be ordered for higher capacity machines (e.g. 12 KLBF Tension Members installed on a 60,000 KLBF calibrating machine based on user’s preferences). Upon ordering a Quick-Change Tension Adapter system, Morehouse Sales team should be consulted to ensure collecting the right information for modifying and customizing the system. Figure 3 displays a set of 120 KLBF Tension Members.

Table 1: Common Tension Members for Quick-Change Tension Adapters System		
Tension Member Part No.	Capacity	To be Used with
TMA-12-4.0-1.000	12,000 LBF	12 KLBF Morehouse Universal Calibrating Machine (UCM)
TMA-12-4.0-1.000	12,000 LBF	30 KLBF Morehouse Universal Calibrating Machine (UCM)
TMA-30-4.5-1.000	30,000 LBF	30 KLBF Morehouse Universal Calibrating Machine (UCM)
TMA-30-5.0-1.188	30,000 LBF	60 KLBF Morehouse Universal Calibrating Machine (UCM)
TMA-30-6.0-1.563	30,000 LBF	100 KLBF Morehouse Universal Calibrating Machine (UCM)
TMA-60-5.5-1.188	60,000 LBF	60 KLBF Morehouse Universal Calibrating Machine (UCM)
TMA-60-6.5-1.563	60,000 LBF	100 KLBF Morehouse Universal Calibrating Machine (UCM)
TMA-120-7.5-1.563	120,000 LBF	100 KLBF Morehouse Universal Calibrating Machine (UCM)
TMA-120-7.5-2.063	120,000 LBF	150 KLBF Morehouse Universal Calibrating Machine (UCM)



Figure 3: Set of 120,000 LBF Tension Members



After installing Tension Members on a calibrating machine, they can be used to mount several types of instruments for tension calibration using intermediate adapters. Other tension adapters, such as Threaded Adapter or Clevises, can be mounted to the Tension Members through two different threaded position on a Tension Member:

- Common thread on the Coupling Nut (internal threads)
- Common thread on Retaining Ring (external thread)

As Figure 4 demonstrates that Tension Members can be used with or without the coupling nut. In both cases, the Tension Member provides the swiveling freedom which can help with attaching additional adapters. The system is normally used with the coupling nuts attached since they reduce the size of intermediate threaded adapters and lower overall adapter cost. However, for large setups, when the tension space in the calibration machine might be limited, the Coupling Nuts could be removed to save some space and connect intermediate adapters directly to the Retaining Ring. This setup is particularly helpful when using Clevises to calibrate large dynamometers and crane scales. Table 2 presents the thread size on Coupling Nut and Retaining Ring for each standard Tension Member assembly.

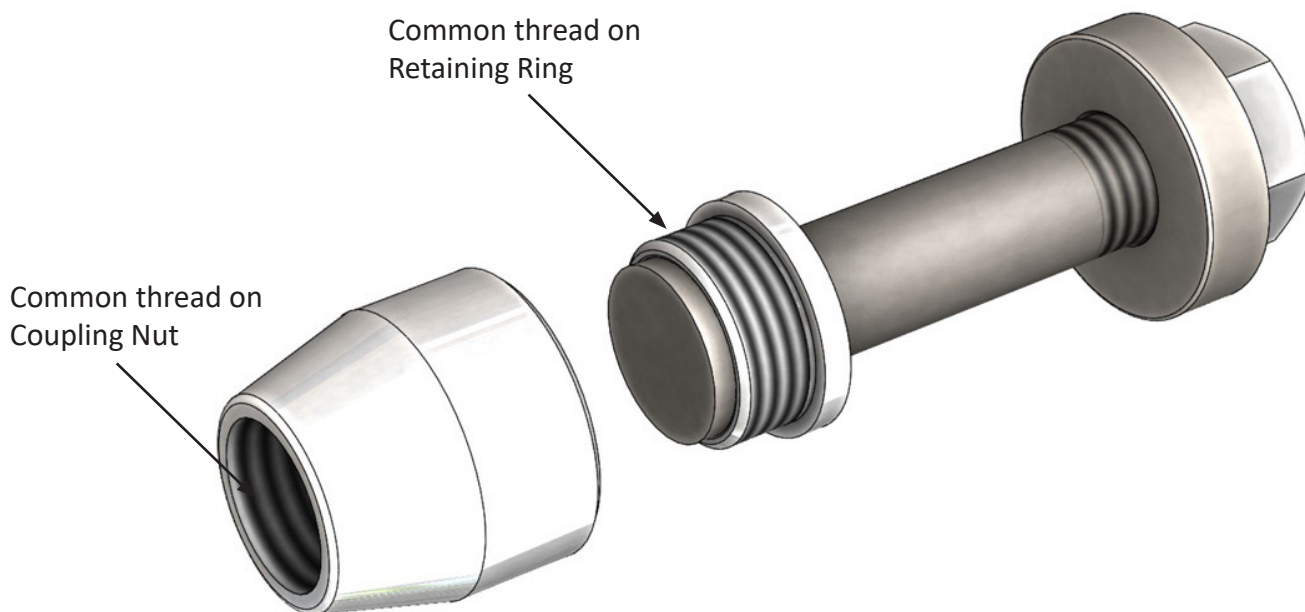

**Figure 4: Two Thread Sizes Available on a Tension Member to Mount Instruments and Adapters**

**Table 2: Adapting Thread Sizes on Common Tension Members**

Tension Member Part No.	Capacity	Coupling Nut Thread	Retaining Ring Thread
TMA-12-4.0-1.000	12,000 LBF	1.125-12 UNF-2B	-
TMA-30-4.5-1.000	30,000 LBF	1.250-12 UNF-2B	1.750-12 UN-2A
TMA-30-5.0-1.188	30,000 LBF	1.250-12 UNF-2B	1.750-12 UN-2A
TMA-30-6.0-1.563	30,000 LBF	1.250-12 UNF-2B	1.750-12 UN-2A
TMA-60-5.5-1.188	60,000 LBF	1.500-12 UNF-2B	2.000-12 UN-2A
TMA-60-6.5-1.563	60,000 LBF	1.500-12 UNF-2B	2.000-12 UN-2A
TMA-120-7.5-1.563	120,000 LBF	2.000-12 UNF-2B	2.500-12 UN-2A
TMA-120-7.5-2.063	120,000 LBF	2.000-12 UNF-2B	2.500-12 UN-2A

## Threaded Adapters

Tension Members in a Quick-Change Tension Adapter setup can be connected to some other force instruments using Threaded Adapters. These adapters are threaded on both sides. From one side they are threaded to match the Coupling Nut as designed for each capacity rating. For example, all the Threaded Adapters used with 120 KLBF Tension Members have 2-12 UNF-2A male thread on one side which matches the female thread of The Coupling Nut in a 120 KLBF Tension Member. From the other side, Threaded Adapters are manufactured at various thread sizes, both male and female, to adapt the system to various instrument sizes. The Threaded Adapters are commonly used to mount instruments such as load cells, ring force gauges, proving rings, or other types of adapters such as clevises.

Morehouse manufactures a large variety of Threaded Adapters in both standard and metric sizes. All adapters have black oxide coating to resist weathering and rusting. Threaded Adapters can be ordered for any size, and many common sizes are normally available in stock. Additionally, Morehouse offers value adapter kits which include a set of Tension Members and several Threaded Adapters that are commonly seen on load cells and other force instruments in the capacity range of the kit. The kits are offered at discounted prices as compared to the price of individual parts. Tables 3 to 6 present the parts included in Morehouse Tension Member Value Kits. Figure 6 shows a set of 120,000 LBF Quick-Change Tension Member Value Kit with associated Threaded Adapters.

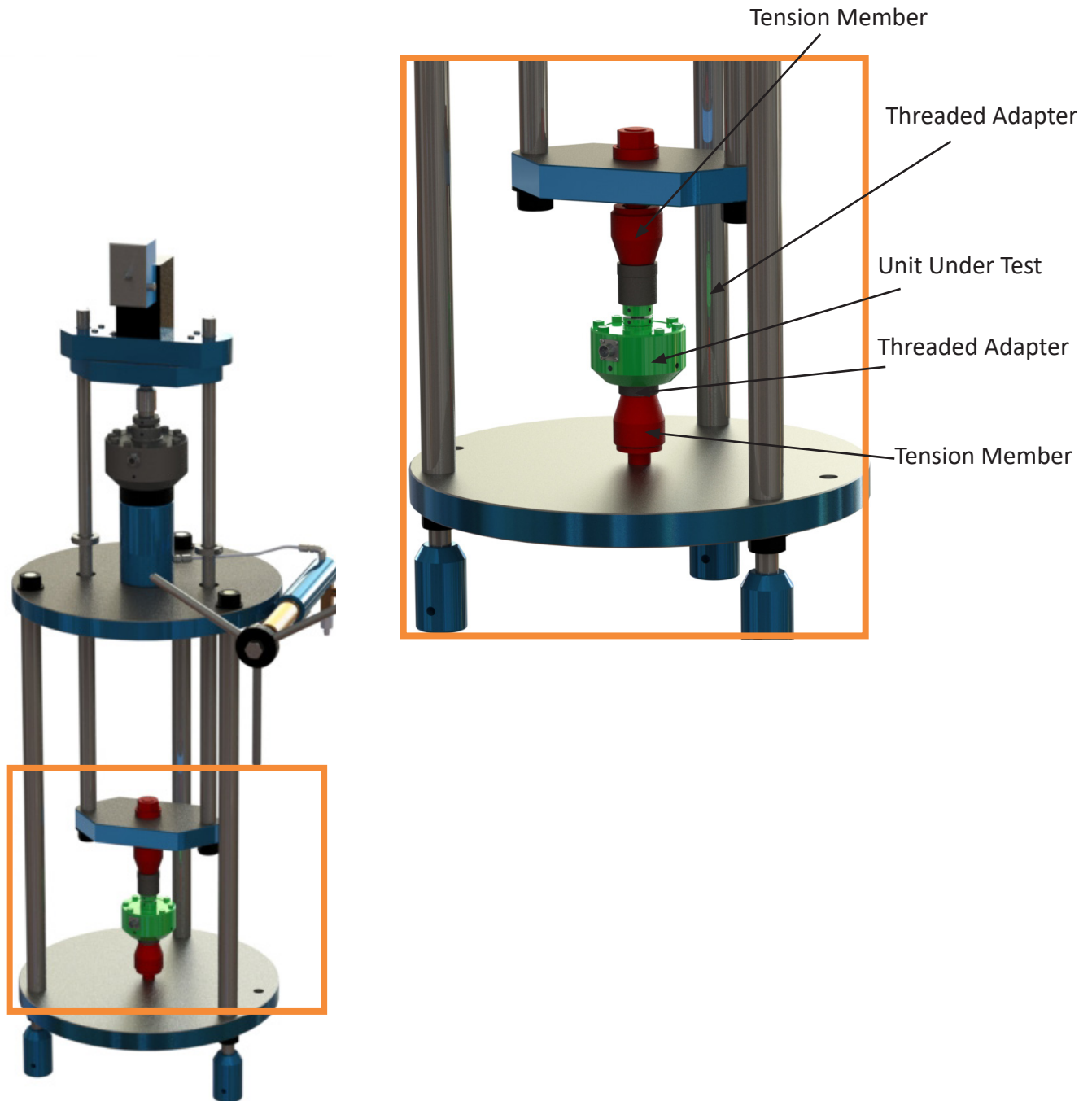

**Figure 5: Using Threaded Adapters to Mount a Load Cell in a Universal Calibrating Machine**



**Table 3: 120,000 LBF Tension Member Adapters Value Kit**

Part Number	Qty.	Capacity (LBF)	Description
<b>Tension Member Assembly</b>			
TMA-120-7.5-1.563	2	120,000	Includes: Tension Rod, Alignment Bushing, Retaining Ring, Coupling Nut, Spherical Nut
<b>Threaded Adapters</b>			
TA-120M(2-12)	2	120,000	Adapter to 2-12 UNF-2A external thread
TA-120M(1.75-12)	2	108,000	Adapter to 1.75-12 UNF-2A external thread
TA-120M(1.5-12)	2	78,000	Adapter to 1.5-12 UNF-2A external thread
TA-120M(1.25-12)	2	53,000	Adapter to 1.25-12 UNF-2A external thread
TA-120M(0.625-18)	2	12,000	Adapter to 0.625-18 UNF-2A external thread
TA-120F(1.75-12)	2	108,000	Adapter to 2-12 UNF-2B internal thread
TA-120F(1.5-12)	2	78,000	Adapter to 1.5-12 UNF-2B internal thread
TA-120F(1.25-12)	2	53,000	Adapter to 1.25-12 UNF-2B internal thread
TA-120F(0.625-18)	2	12,000	Adapter to 0.625-18 UNF-2B internal thread

**Table 4: 60,000 LBF Tension Member Adapters Value Kit**

Part Number	Qty.	Capacity (LBF)	Description
<b>Tension Member Assembly</b>			
TMA-60-5.5-1.188	2	60,000	Includes: Tension Rod, Alignment Bushing, Retaining Ring, Coupling Nut, Spherical Nut
<b>Threaded Adapters</b>			
TA-60M(1.5-12)	2	60,000	Adapter to 1.5-12 UNF-2A external thread
TA-60M(1.25-12)	2	53,000	Adapter to 1.25-12 UNF-2A external thread
TA-60M(1-14)	2	33,000	Adapter to 1-14 UNS-2A external thread
TA-60M(0.625-18)	2	12,000	Adapter to 0.625-18 UNF-2A external thread
TA-60F(1.25-12)	2	53,000	Adapter to 1.25-12 UNF-2B internal thread
TA-60F(1-14)	2	33,000	Adapter to 1-14 UNS-2B internal thread
TA-60F(0.625-18)	2	12,000	Adapter to 0.625-18 UNF-2B internal thread



**Table 5: 30,000 LBF Tension Member Adapters Value Kit**

Part Number	Qty.	Capacity (LBF)	Description
<b>Tension Member Assembly</b>			
TMA-30-4.5-1.000	2	30,000	Includes: Tension Rod, Alignment Bushing, Retaining Ring, Coupling Nut, Spherical Nut
<b>Threaded Adapters</b>			
TA-30M(1.25-12)	2	30,000	Adapter to 1.25-12 UNF-2A external thread
TA-30M(1-14)	2	30,000	Adapter to 1-14 UNS-2A external thread
TA-30M(0.625-18)	2	12,000	Adapter to 0.625-18 UNF-2A external thread
TA-30M(0.5-20)	2	8,000	Adapter to 0.5-20 UNF-2A external thread
TA-30F(1-14)	2	33,000	Adapter to 1-14 UNS-2B internal thread
TA-30F(0.625-18)	2	12,000	Adapter to 0.625-18 UNF-2B internal thread
TA-30F(0.5-20)	2	8,000	Adapter to 0.5-20 UNF-2B internal thread

**Table 6: 12,000 LBF Tension Member Adapters Value Kit**

Part Number	Qty.	Capacity (LBF)	Description
<b>Tension Member Assembly</b>			
TMA-12-4.0-1.000	2	12,000	Includes: Tension Rod, Alignment Bushing, Retaining Ring, Coupling Nut, Spherical Nut
<b>Threaded Adapters</b>			
TA-12M(0.625-18)	2	12,000	Adapter to 0.625-18 UNF-2A External Thread
TA-12M(0.5-20)	2	8,000	Adapter to 0.5-20 UNF-2A External Thread
TA-12M(0.375-24)	2	4,000	Adapter to 0.375-24 UNF-2A External Thread
TA-12M(0.25-28)	2	1,800	Adapter to 0.25-28 UNF-2A External Thread
TA-12F(0.625-18)	2	12,000	Adapter to 0.625-18 UNF-2B Internal Thread
TA-12F(0.5-20)	2	8,000	Adapter to 0.5-20 UNF-2B Internal Thread
TA-12F(0.375-24)	2	4,000	Adapter to 0.375-24 UNF-2B Internal Thread
TA-12F(0.25-28)	2	1,800	Adapter to 0.25-28 UNF-2B Internal Thread



**Figure 6: 120,000 Quick-Change Tension Adapters Value Kit**

## Clevises

Calibration of some force measurement instruments, such as dynamometers and crane scales, require using clevis adapters in a calibrating machine. Morehouse has designed and manufactured several Clevis assemblies for calibrating various standard instruments on the market and continues to design custom Clevises for all sorts of special applications. A Morehouse Clevis assembly normally includes a clevis, a loading pin, and a detent pin for increased safety of the calibration.

For some instruments, the diameter of the clevis pin can impact the calibration results. Therefore, manufacturers often specify the pin diameter that must be used with the instrument for both calibration and field use. A calibration lab needs to follow this direction and obtain a pin with the right diameter which satisfies safety precautions of the calibration as well. Morehouse Engineering team evaluates the calibration condition to ensure that the system can stand the applied forces with proper safety factor. In addition, in some cases, a smaller pin can be used with a clevis using clevis bushings. The bushings are placed between the pin and the clevis hole to center the pin and transfer the load properly.

Clevis rollers and additional clevis pins can be added to a Morehouse Clevis assembly to increase the number of instruments that can be calibrated by a set of Clevises. However, Morehouse Sales and Engineering teams need to be consulted upon placing an order for design and feasibility considerations. Clevises are normally ordered in pairs to mount an instrument into a calibrating machine. Nonetheless, in some special cases a tensile force measurement setup might have two different types of mounting systems at its ends. For instance, a clevis might be combined with a rod end or a threaded adapter to mount the instrument into a calibrating machine.

## Mounting a Clevis

Standard Morehouse Clevis assemblies are adaptable to the Quick-Change Tension Adapters system. A clevis can be attached to a Tension Member in two possible ways based on the thread size on the clevises' mounting hole:

1. Using an intermediate Threaded Adapter to attach the clevis to the Coupling Nut
2. Attaching the Clevis directly to the Retaining Ring after removing the Coupling Nut from the Tension Member.

Figure 7 illustrates the two methods of attaching a Clevis to a calibrating machine through Quick-Change Tension Adapters system. As can be seen in this figure, the Tension Members can be used with multiple Clevises and other adapters. Thus, Quick-Change Clevises do not need to be made with a dedicated tension rod individually and this lowers the long-term cost of acquiring Clevises for a calibration laboratory. Furthermore, the Clevis assembly benefits from the self-alignment features built into the Quick-Change Tension Adapters system, and the swiveling freedom of the Tension Members helps with easier and faster setup.

The thread on the mounting hole of a standard Morehouse Clevis is made to the size that fits the Retaining Ring of the Quick-Change Tension Member for the same capacity range. This is due to the fact that for larger instruments, the length of the tension area in a calibrating machine becomes critical and removing the Coupling Nuts from two Tension Members helps provide more space for mounting the unit under test. For instance, if a Clevis is made for 30 KLBF Quick-Change Tension Members, it will be attached to the Tension Member through the Retaining Ring (Figure 7b). But attaching the same clevis to a 120 KLBF Tension Member will be done through the Coupling Nut and using a Threaded Adapter (Figure 7a). Table 7 contains the standard thread sizes of Morehouse Quick-Change Clevises. It should also be noted that 12,000 LBF Tension Members do not have a Retaining Ring and the Coupling Nut is directly placed on the Tension Rod; thus, a Threaded Adapter will be needed to mount a clevis to a 12,000 LBF Tension Member.

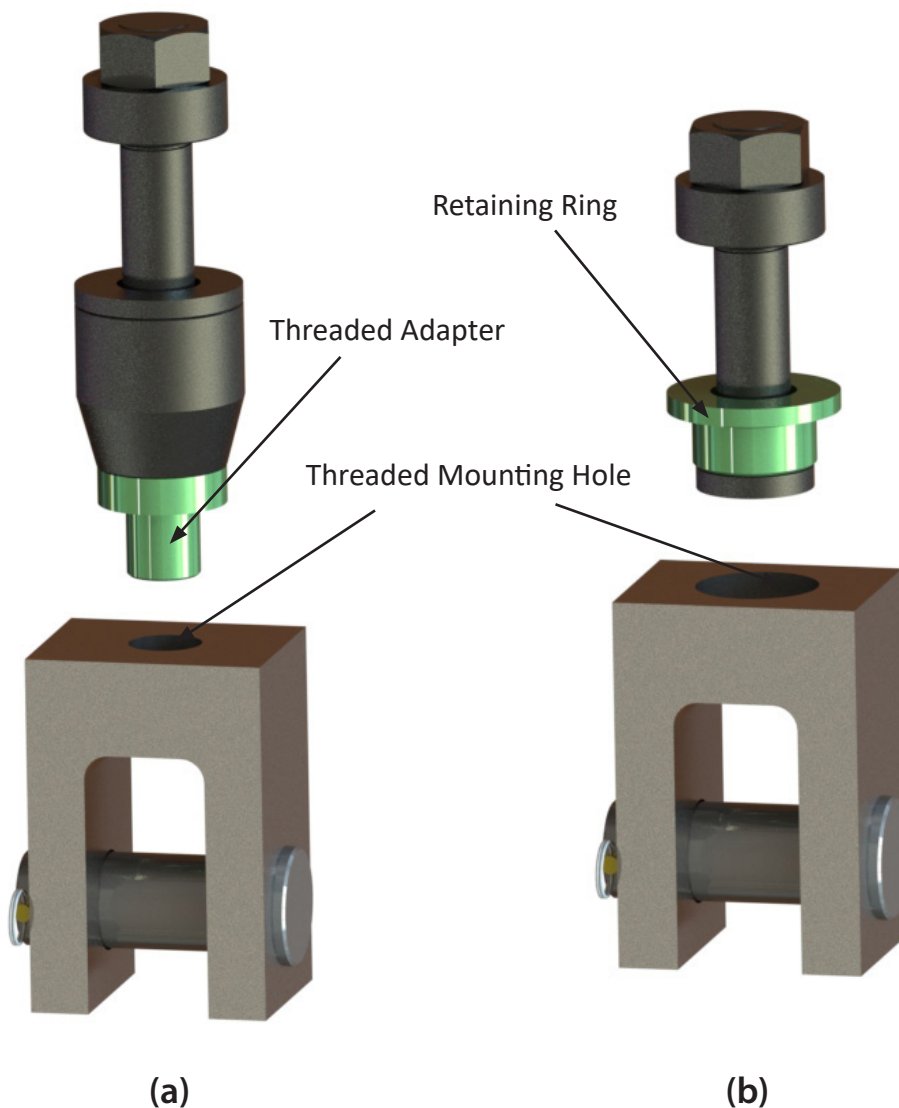

**Figure 7: Mounting a Clevis in a Calibrating Machine Using Tension Members; a) through a Threaded Adapter and Coupling Nut, b) through Retaining Ring**

**Table 7: Standard Thread Size for Morehouse Clevises**

Capacity Range	Clevis Mounting Hole Thread (Internal)	Tension Member Capacity → Retaining Ring Thread
$C \leq 12$ KLBF	0.625-18 UNF-2B	12 KLBF Tension Member → N/A; use threaded adapter
$12 < C \leq 30$ KLBF	1.750-12 UN-2B	30 KLBF Tension Member → 1.750-12 UN-A
$30 < C \leq 60$ KLBF	2.000-12 UN-2B	60 KLBF Tension Member → 2.000-12 UN-A
$60 < C \leq 120$ KLBF	2.500-12 UN-2B	120 KLBF Tension Member → 2.500-12 UN-A



In addition to the standard Quick-Change Clevises, Morehouse manufactures custom design Clevises based on specific requirements defined by the user. In case custom Clevises did not have the Morehouse standard threads on the mounting hole (because of user's requirements, or Engineering and design considerations), Threaded Adapters can be used as intermediate adapters to mount the Clevis to the desired Tension Member.

## Clevis Pins

A Quick-Change clevis assembly is consisted of a Clevis, a Pin, and a detent pin which limits the movement of the Clevis Pin and provides a safer setup during calibration. Two general types of pins can be supplied with any Quick-Change Clevis: Straight Pin, and Shoulder Pin with Bushing.

### Straight Pin

By default, a Quick-Change Clevis assembly is supplied with a standard Straight Pin which fits the original hole size of the clevis. As shown in Figure 8(a), Straight Pin is designed and manufactured to fit the side holes on the Clevis. A Straight Pin is supplied with every Clevis Assembly purchased from Morehouse.

### Shoulder Pin with Bushing

Shoulder Pins with Bushings can be manufactured to be used with the same clevis and calibrate various instruments that may need different pins sizes. Several Shoulder Pin with Bushings can be ordered for the same Quick-Change Clevis. Hence, Shoulder Pin with Bushings make a Quick-Change very versatile and translate into remarkable cost savings for force calibration laboratories. Morehouse has designed kits of Clevis Assemblies with various Shoulder Pins which can be used to calibrate numerous dynamometers and crane scales in the same capacity range.

As Illustrated in Figure 8(b), Shoulder Pin with Bushings are often used to generate pin sizes with smaller diameters than the original Straight Pin for each Clevis. A Shoulder Pin is passed through the Clevis and instrument. Then the bushing is used to mount the Pin into the Clevis, and the whole assembly is fixed together using a detent pin. In other words, a Shoulder Pin with Bushing is an assembly on its own which can be designed at various sizes. Figure 9 demonstrates the concept and assembly of a Shoulder Pin with Bushing for Quick-Change Clevises.

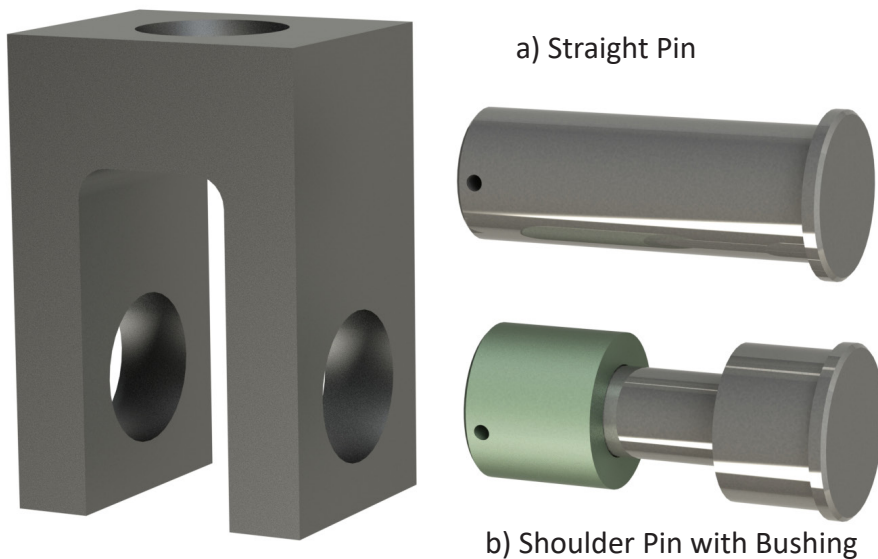

**Figure 8: Two General Types of Pins for Quick-Change Clevises:**  
a) Straight Pins (Standard and Included with Clevis); b) Shoulder Pins with Bushing

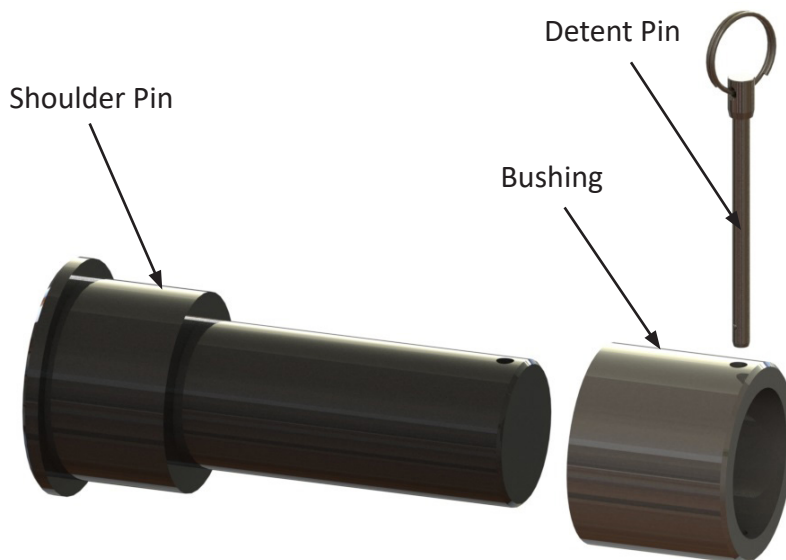

**Figure 9: Shoulder Pin with Bushing Assembly for Quick-Change Clevises**

It is noteworthy to mention that the design of a Clevis and its related Pins are highly dependent on the capacity and size of the instruments calibrated with them. If the user intends to calibrate several instruments with the same clevis and different Pins, normally the size of the largest instrument dictates the opening and depth of the Clevis. Nonetheless, calibrating a smaller instrument with the same capacity and I the same clevis might not be feasible. This is because the smaller instrument might use a significantly narrower Pin which could require a much smaller support span to prevent bending. Therefore, in some cases, the user might need two or more clevises to calibrate all the desired instruments using the Quick-Change Adapters System. Morehouse has designed standard Quick-Change Clevises optimized to calibrated numerous instruments available on the market and provided by different manufacturers. Morehouse Sales team can be contacted for purchasing the standard Clevises for which several Pins have been designed and can be added to the system for future expansion.

## Clevis Pin Rollers

Clevis Pins are normally designed to have a certain amount of contact surface with the unit under test. Since the size and quality of this contact area could have an impact of the calibration results for some force instruments, the diameter of a Clevis Pin is specified by the manufacturer of the force instrument in many cases. However, some dynamometers and tension links might be manufactured and supplied with loading shackles. The shackles are fixed to the mounting holes of the instrument through a pin and the system provides a consistent loading configuration to the dynamometer. The round configuration of most shackles may impose highly concentrated forces to the Clevis Pins which often results in damaged spots on Clevis Pins. To address this issue, Quick-Change Clevis assemblies can be ordered with Pin Rollers to protect the Pin against concentrated forces and resulting damages.

As demonstrated in Figure 10a, when a force instrument such as a dynamometer is being mounted into a calibrating machine using Quick-Change Clevises and through its original mounting holes, the Clevis Pin is in direct contact with the dynamometer. But when the dynamometer is being calibrated with the loading shackles supplied by the user, the Roller is placed between the Clevis Pin and the Shackles. The roller might have a small contact area with the shackle; however, it transfers the force to a larger surface area on the Clevis Pin and prevents permanent damages to the Clevis Pin. Figure 10b displays using a Pin Roller to mount a dynamometer with shackles to a Quick-Change Clevis, and Figure 10c shows the assembly of the Clevis Pin and Pin Roller.

As mentioned earlier, a Quick-Change Clevis might be used with multiple pins. All Quick-Change Clevis Pins, both Straight and Shoulder Pins, can be ordered with Rollers to be protected against concentrated forces during calibrations.

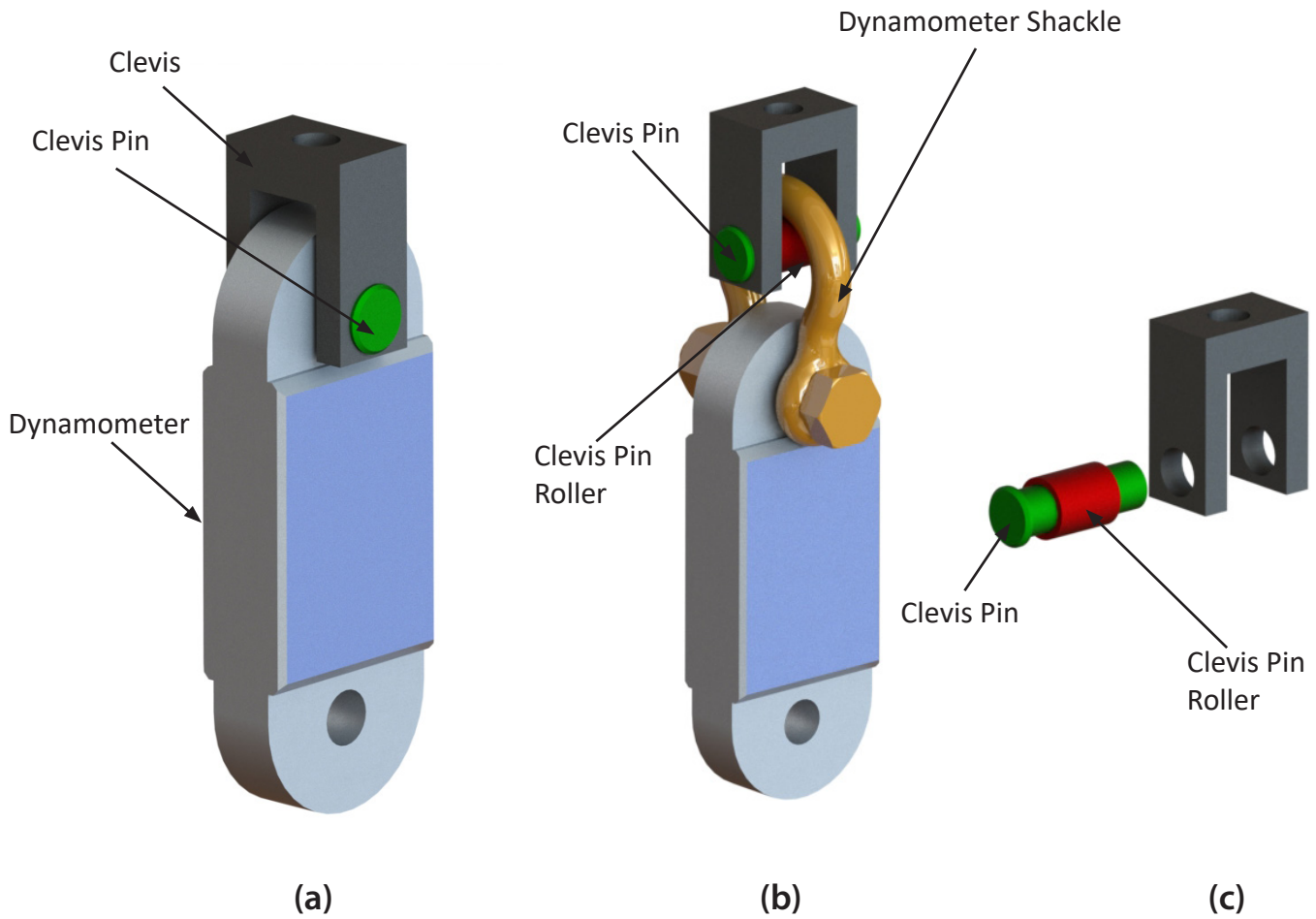

**Figure 10: a) Mounting a Dynamometer to Clevis through Instrument's Mounting Hole;  
b) Mounting a Dynamometer to Clevis through Loading Shackle;  
c) Clevis Pin and Roller Assembly**



## Numbering Schema

The part numbering system of Quick-Change Tension Adapters is designed to correlate various parts in an assembly. Based on the issued part numbers, Morehouse production team can identify and manufacture the individual parts in an assembly.

### Tension Member



# TMA-C-TR-TB

Tension Member  
Capacity in KLBF

Hole diameter in lower  
yoke platen (in.)<sup>1</sup>

Length of Tension  
Rod (in.)<sup>2</sup>

<sup>1</sup> This value shows the diameter of the hole where the Tension Rod passes through. In a Morehouse Universal Calibrating Machine, this hole is made at the center of the lower yoke platen.

<sup>2</sup> Refer to the numbering schema for Tension Rods for more information.

### Spherical Hex Nut



# TH-C

Tension Member  
Capacity in KLBF



### Spherical Alignment Bushing

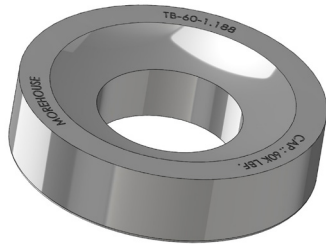

**TB-CC-DDD**

Tension Member  
Capacity in KLBF

Hole diameter in  
lower yoke platen  
(in.)<sup>1</sup>

<sup>1</sup> This value shows the diameter of the hole where the Tension Rod passes through. In a Morehouse Universal Calibrating Machine, this hole is made at the center of the lower yoke platen.

### Tension Rod

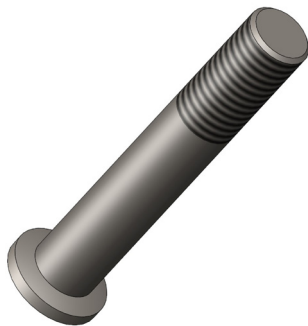

**TR-CC-LLLL**

Tension Member  
Capacity in KLBF

Length of Tension  
Rod (in.)

### Retaining Ring

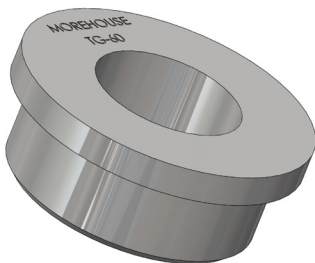

**TG-CC**

Tension Member  
Capacity in KLBF



### Coupling Nut

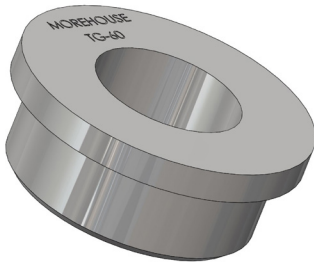

**TC-CC**

Tension Member  
Capacity in KLBF



### Threaded Adapter

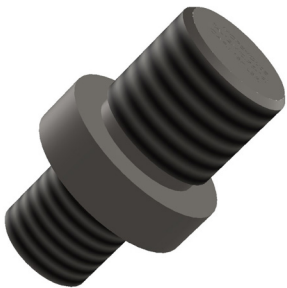

**TA-CCX-SSSS-PP**

Tension Member  
Capacity in KLBF



Thread Type <sup>1</sup>



Thread Size <sup>2</sup>



<sup>1</sup> 'M' for male or external threads | 'F' for female or internal threads

<sup>2</sup> This field indicates thread dimensions.

For standard threads, thread diameter and TPI are shown; e.g. 0.75 inch thread with 10 threads per inch is shown as: 0.750-10

For Metric threads, letter 'M', thread diameter and thread pitch is indicated; e.g. 16 millimeter thread with 1.5 millimeter thread pitch is shown as: M16-1.5



## Clevis Assembly

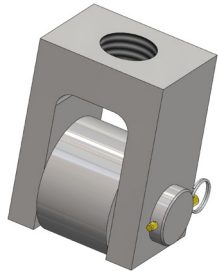

# TUA-CC-XXX-YYO

Tension Member  
Capacity in KLBF

Clevis designation <sup>1</sup>

Roller option <sup>3</sup>

Pin designation <sup>2</sup>

<sup>1</sup> Same designation used in the Clevis part number (TU)

<sup>2</sup> Same designation used in the Clevis Straight Pin (TP) and Clevis Shoulder Pin (TZ) part numbers

<sup>3</sup> Option for having protective roller; 'O': protective roller (TO Part) | 'Blank': No roller

## Clevis

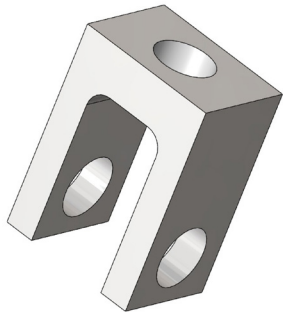

# TU-CC-XXX

Tension Member  
Capacity in KLBF

Clevis designation  
number

## Clevis Straight Pin



# TP-CC-XXX-YY

Tension Member  
Capacity in KLBF

Clevis designation <sup>1</sup>

Pin designation <sup>2</sup>

<sup>1</sup> Same designation used in the Clevis part number (TU)

<sup>2</sup> Unique designation number between 0 and 50 for straight pins





### Clevis Pins with Bushings Assembly



# TUZ-CC-XXX-YY

Tension Member  
Capacity in KLBF

Pin designation <sup>2</sup>

Clevis designation <sup>1</sup>

<sup>1</sup> Same designation used in the Clevis part number (TU)

<sup>2</sup> Same designation used in the Clevis Shoulder Pin part number (TZ)

### Clevis Shoulder Pin



# TZ-CC-XXX-YY

Tension Member  
Capacity in KLBF

Pin designation <sup>2</sup>

Clevis designation <sup>1</sup>

<sup>1</sup> Same designation used in the Clevis part number (TU)

<sup>2</sup> Unique designation number between 51 and 99 for shoulder pins



### Clevis Pin Bushing

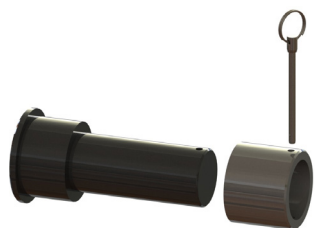

Tension Member  
Capacity in KLBF

**TY-CC-XXX-YY**

Pin designation <sup>2</sup>

Clevis designation <sup>1</sup>

<sup>1</sup> Same designation used in the Clevis part number (TU)

<sup>2</sup> Same designation used in the Clevis Shoulder Pin part number (TZ)

### Clevis Pin Roller

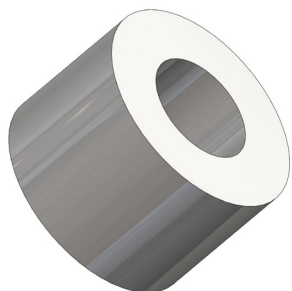

Tension Member  
Capacity in KLBF

**TX-CC-XXX**

Pin designation 1

<sup>1</sup> Same designation used in the Clevis part number (TU)

Clevis pin rollers are made only for the original straight pin for each clevis.